

**0 77**

MEDIUM OVAL

**springfree**<sup>®</sup>  
TRAMPOLINE  
THE SMART TRAMPOLINE™

## Assembly and Disassembly Instructions for Trampoline and Enclosure

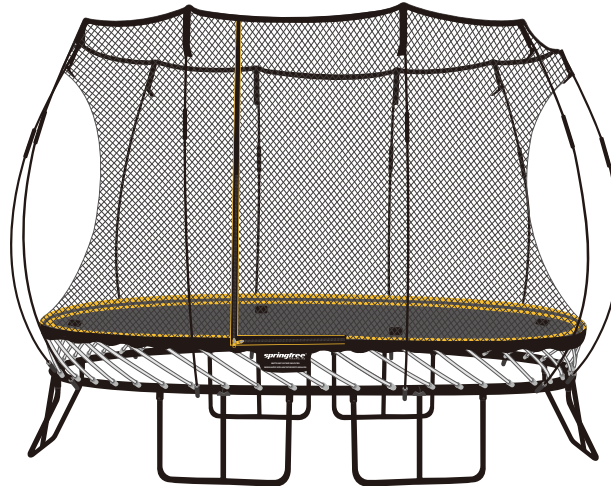

---

MAT DIAMETER	MINIMUM NET HEIGHT FROM MAT	MAT HEIGHT FROM GROUND	MAXIMUM USER WEIGHT
7.8 ft x 11 ft (2.4 m x 3.4 m)	6 ft (1.8 m)	3 ft (0.9 m)	220 lbs (100 kg)

---

The information in this document is subject to change without notice.  
© Copyright Springfree® Trampoline Inc. 2005, 2017. All rights reserved.

736604



# WARNING

Read the warnings on this page and those contained in the User Guide before you assemble and use the trampoline and enclosure.



Treat any loaded rod with caution until you are sure it is properly installed or uninstalled. Keep face clear of loaded rods. An improperly installed rod could release and cause facial injury or blindness.



No more than one person at a time. Multiple jumpers increase the chances of loss of control and collision and can result in serious head, neck, back, leg, arm or other injuries.



No somersaults or flips. Landing on the head or neck can cause serious injury, paralysis, or death, even when landing in the middle of the bed.



Never attempt to remove a black net rod from its net pocket or disengage (unlock) the rod sleeve while the black net rod is under tension.



Do not hold onto, or place fingers between the rods while someone is jumping on the trampoline.



If you anticipate severe weather, consider lowering the enclosure, moving the trampoline to a sheltered location or disassembling the trampoline completely.



Entrapment and choking hazard possible for children under 6 years of age.



The Maximum User Weight for this trampoline is located on the front panel of this manual. Jumpers at or near the Maximum User Weight should take extra precautions in their manoeuvres to ensure they do not initiate contact with the ground while jumping as this can cause serious injury.



We have helpful demonstration videos that will guide you through each step. Visit <http://springfr.ee/install-ov> or scan the code in Step 1 to get started.



# WARNING

Please read the following precautions carefully before beginning the assembly process. Retain for future reference.

- A. Two people are required for assembly. Installation typically takes two hours to complete.
- B. Keep small children at least 25 ft (7.5 m) away while assembling the trampoline; they could be injured by improperly assembled rods releasing and ejecting from the frame.
- C. Do not attempt to use the trampoline until it is completely assembled.
- D. Be aware that when loaded, the rods can spring back and may cause injury. Keep your face well clear of the rods during assembly or disassembly. An improperly installed rod could release and cause facial injury or blindness.
- E. The sleeves on the rods are intended to provide protection from fibres or splinters. Do not remove. If they are damaged, replace them.
- F. Maintain a minimum clearance of 16.5 ft. (5 m) above the mat [in USA and Canada, 24 ft (7.3 m) above the trampoline from ground level] in order to prevent users from inadvertently contacting overhead hazards such as electric wires, tree limbs or clothesline.
- G. Maintain a minimum clearance of 5 ft (1.5 m) [in EU countries, 6.5 ft (2.0 m)] on all sides of the trampoline. This area should not include concrete, bitumen, brick or other hard surfaces or be in the proximity of other conflicting installations (e.g. pools, swings, slides, climbing frames) as these can cause serious injuries if users fall off the trampoline.
- H. Do not locate the trampoline on top of other objects or store anything underneath the trampoline bed.
  - I. Place the trampoline in a well-lit area.
  - J. Record the date of purchase on the enclosure label in the space provided.
  - K. Only use approved Springfree® Trampoline accessories, and install in accordance to installation instructions. Do not make modifications to the trampoline or accessories.
  - L. Secure the trampoline against unauthorized and unsupervised use.
  - M. The owner and supervisors of the trampoline are responsible to make all users aware of practices specified in the User Guide.
  - N. Trampoline enclosure is supplied as part of the trampoline. Do not install enclosures that are not suited to your product.
  - O. The trampoline is intended for indoor/outdoor usage. Refer to Trampoline location information in the User Guide for more details.
  - P. Use only with mature, knowledgeable supervision. Enforce all safety rules.
  - Q. Record the purchase date of your trampoline on the net serial number tag. It is located under the net warnings, which are sewn into the edge of the net next to the entrance.

# 1



Part	Quantity	Part	Quantity
A. Mat	1	D. Black Net Rods	10
B. White Mat Rods	52	Spare Small Bolt & Nut	1
C. Net	1	Spare C-clips	3

- Lay out the parts as shown.



SCAN HERE or visit <http://springfr.ee/g4-install-ov> for a helpful installation overview video.

# 2

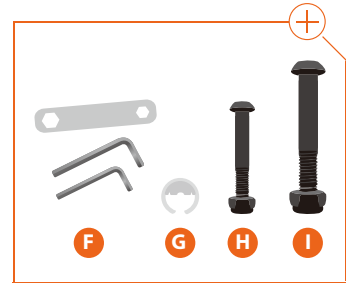
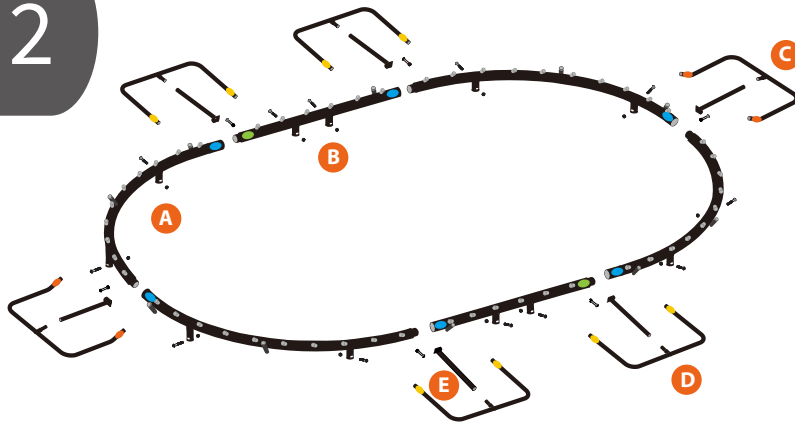

Part	Quantity	Part	Quantity
A. Curved Frame Sections	4	F. Wrenches	3
B. Straight Frame Sections	2	G. C-clips (Attached to Frame)	10
C. Orange Bent Legs	2	H. Small Bolts & Nuts	12
D. Yellow Legs	4	I. Large Bolts & Nuts	6
E. Center Posts	6		



**WARNING** - Use the tools provided to fasten the nuts. Do not over tighten the nuts. Do not use power driver, torque wrench, or drill.

- Lay out the remaining parts as shown. The colored stickers all face upwards.
- If you are missing any parts please contact Springfree Trampoline directly.



SCAN HERE or visit <http://springfr.ee/g4-step-2> for a helpful installation video for Step 2.

3

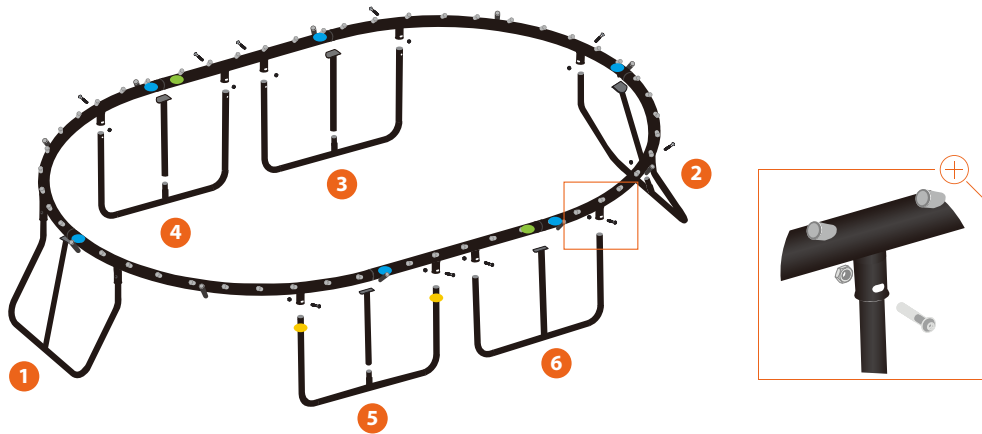

**TIP** - Fastening the final two frame sections often requires additional effort. Two people are required for assembly.

**TIP** - When installing the legs, it is easiest when one person holds the frame up and horizontal while the other person inserts the legs into the leg sockets.

- Connect and fasten frame sections using the large nuts and bolts. When finished, the bolt head should be flush with the frame and the nut should face the center of the trampoline.
- Attach a center post to the middle of each leg section.
- Then, in the order shown, carefully lift the frame and evenly insert the legs into the leg sockets on the underside of the frame.
- Fasten each leg to the frame using the small nuts and bolts before going to the next leg.

4

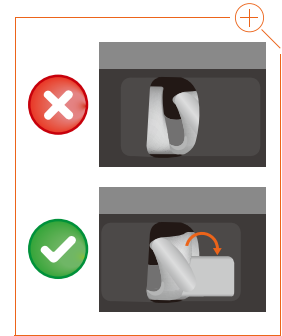
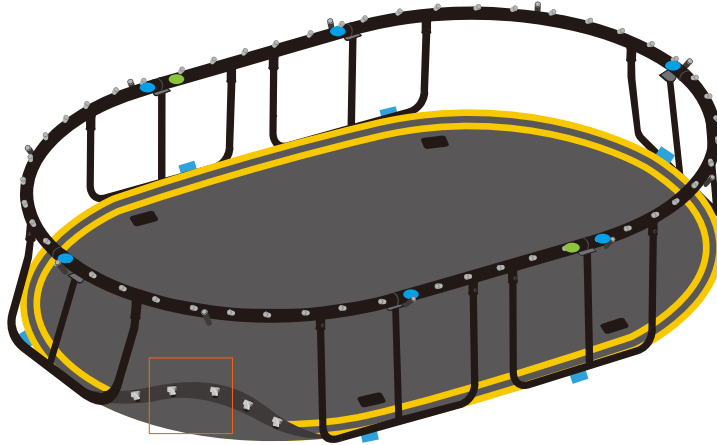

- Lay out the mat with the yellow stripes facing upwards inside the trampoline frame.
- The blue ■ tags on the mat should approximately align with the blue ● stickers on the frame.
- Before moving to the next step, ensure that the mat rod holders are correctly positioned with the mat rod holder tag outside the mat rod holder pocket, as per the insert. If the mat rod holder tag is under the pocket, adjust accordingly.

5

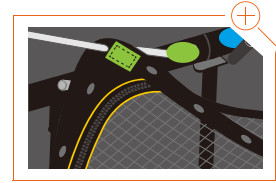
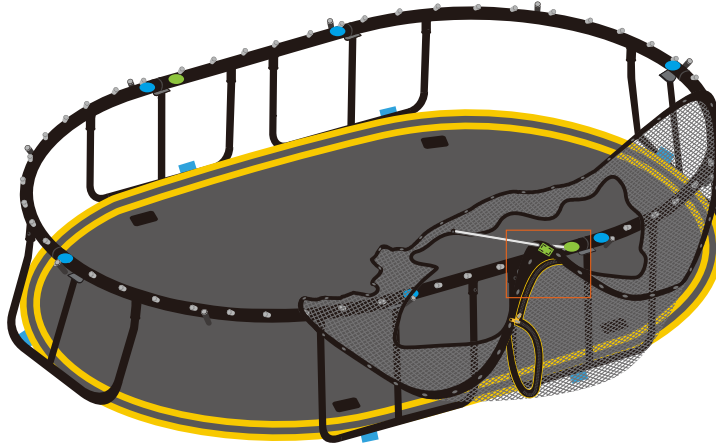

**STOP**

**NOTE** - As you install the white mat rods into the mat rod sockets the net will become tight against the frame. Handle the net with care and be sure that it does not get caught or it may tear.

- Locate the green ■ tag on the bottom edge of the net and match it with any green ● sticker on your trampoline frame.
- Holding the net so that the green ■ tag is facing you, gently place the rest of the net inside the frame as shown. DO NOT let go of the green ■ tag.
- Put a white mat rod through the hole to the immediate left of the green ■ tag in the net and then into the mat rod socket next to the green ● sticker.
- Then, working carefully around the frame, insert the remaining white mat rods through the net holes and into the corresponding mat rod socket. When finished, the net should be stretched tightly around the OUTSIDE of the frame.
- Be sure that the white mat rods are seated down to the bottom of each mat rod socket.



SCAN HERE or visit <http://springfr.ee/g4-step-5> for a helpful installation video for Step 5.



6a

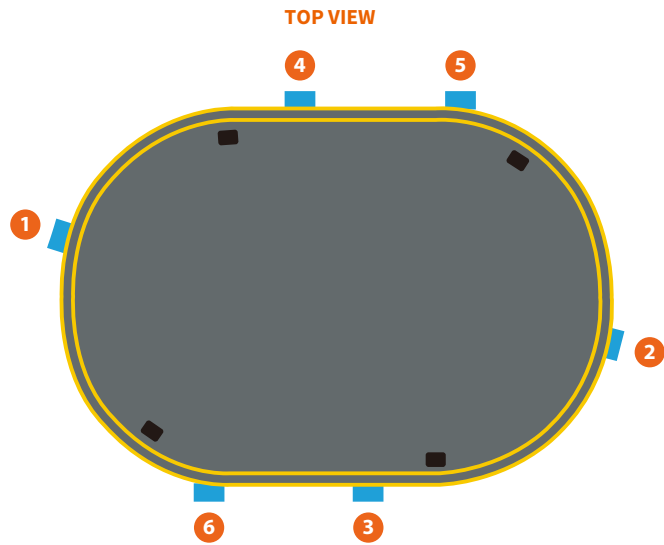
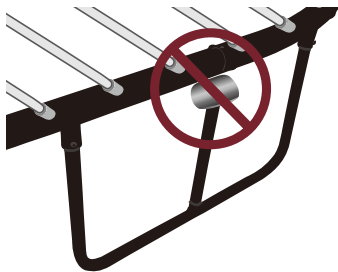

**WARNING** - Treat any loaded rod with caution until you are sure it is properly installed or uninstalled. Keep your face well away from any loaded rod.

**WARNING** - Both people must maintain a steady grip on the rod until it is securely installed in the mat rod holder.



**NOTE** - Before you install the first white mat rod into a mat rod holder, read the instructions in Step 6b and 6c.

**NOTE** - Following the sequence shown spreads the tension evenly across the mat. If you do not follow this sequence, it will be very difficult to attach the mat.

- Check that the center posts of the leg sections are correctly seated under the trampoline frame. If they are not, adjust them now.
- To install the mat, begin by attaching one white mat rod at each location where the blue ■ tags on the mat match with the blue ● stickers on the frame.

# 6b

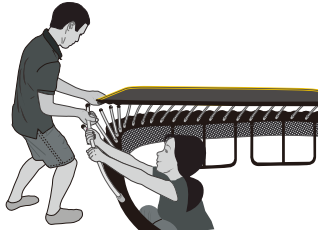

**1** Have one person position themselves inside the frame of the trampoline while the other stands outside as shown.

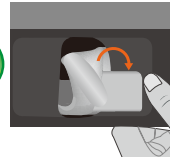
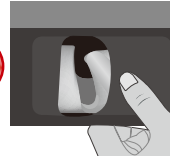

**2 Inside Person:** Ensure that the mat rod holder is correctly positioned with the small tag positioned outside the mat rod holder pocket.

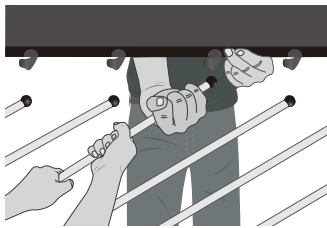

**3 Inside Person:** Take hold of the rod with both hands and maintain a steady grip until it is securely installed in the mat rod holder.

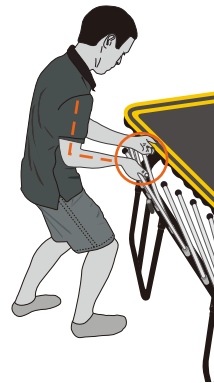

**4 Outside Person:** Hold the white mat rod with your palm facing up and bend your arm at a right angle.

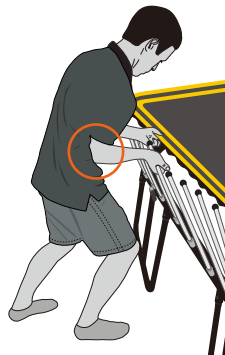

**5 Outside Person:** Stand with one leg forward and bend your knees. Push your elbow into your hip.

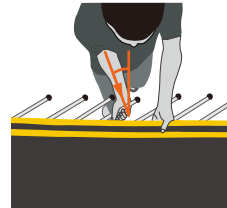

**6 Outside Person:** Pushing across your body in the direction shown will make it easier to get the mat rods in or out of the mat rod holders.

6c

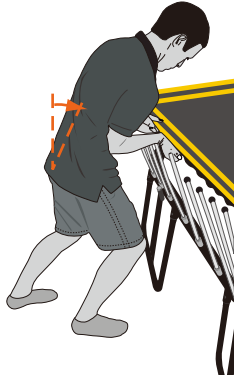

**7 Outside Person:** Rocking from your heels to the balls of your feet, use your body weight to push the white mat rod towards the center of the mat.

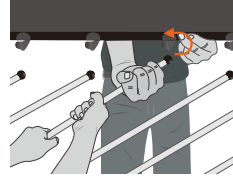

**8 Inside Person:** As the outside person pushes, carefully pull the rod in and up in the direction of the mat rod holder.

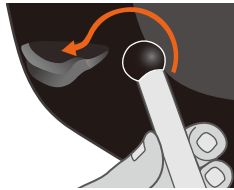

**9 Inside Person:** Guide the white mat rod up and over the back edge of the mat rod holder and into position. Check that the rod is fully seated in the mat rod holder before continuing.



**10 Outside Person:** Do not twist or rotate the mat to remove a rod from a mat rod holder. This could cause serious injury or damage the trampoline.



**TIP** - Keep the mat level when you install or uninstall the white mat rods.  
**TIP** - If you need to uninstall a white mat rod, see the Disassembly Instructions on the reverse.



SCAN HERE or visit <http://springfr.ee/g4-step-6> for a helpful installation video for Step 6.

# 7

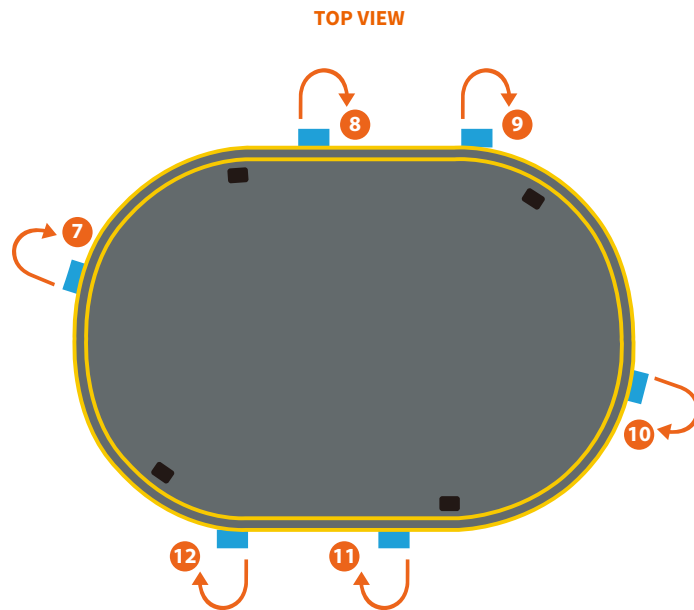

**WARNING** - Treat any loaded rod with caution until you are sure it is properly installed or uninstalled. Keep your face well away from any loaded rod.



**NOTE** - Follow the mat rod installation sequence. Do not install multiple mat rods in one location. If you do not follow this sequence, it will be very difficult to attach the mat.  
**NOTE** - Each time you circle the trampoline, check that the center posts of the leg sections are correctly seated under the trampoline frame. If they are not, adjust them before installing any more rods. You may need to uninstall rods to release the tension.

- Go back to the very first rod you attached to the mat in Step 6a. Now, moving clockwise, attach ONE white mat rod next to the initially installed rod.
- Moving clockwise around the trampoline, attach ONE additional rod next to each of the already installed rods as shown above.
- Continue circling the trampoline several more times following this sequence, installing only ONE rod per grouping, until all the white mat rods are attached to the mat.

8

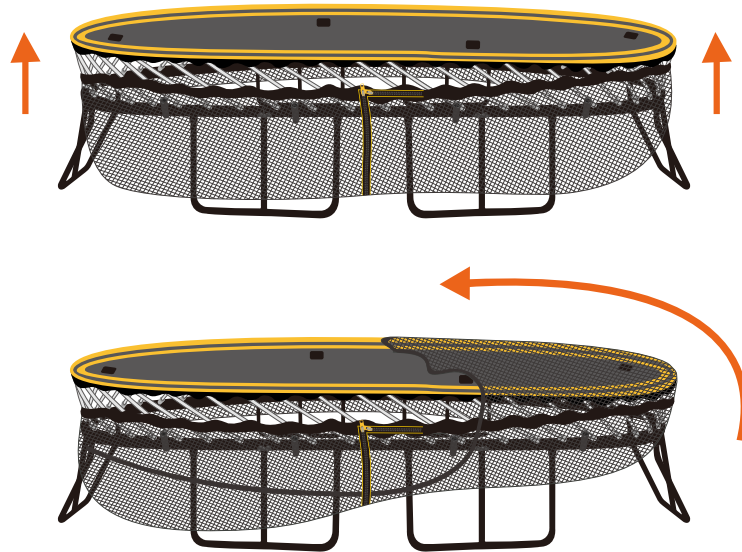

**WARNING** - Do not use the trampoline until it is completely assembled. Failure to follow these instructions may cause rods to break or eject from the trampoline frame.



**NOTE** - Check that the net is not caught on the trampoline frame or the bolts – if the net catches, it may tear.

- Moving clockwise around the frame, carefully slide the net up to the top of the white mat rods.
- Then, starting at one of the blue stickers on the curved frames, gently and slowly pull the net up and over the edge of the mat. It is normal for the net to be tight. Take extra care not to tug the net and check that the net is not snagged on the trampoline frame or the bolts.
- Working slowly around the frame, carefully lift the rest of the net over the edge of the mat until the bottom band of the net is pulled all the way to the top of the white mat rods.

9

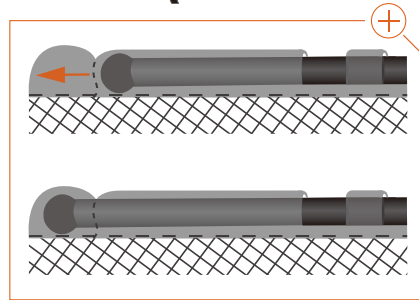
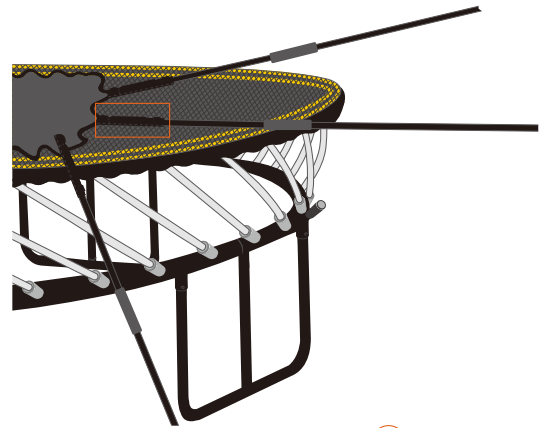
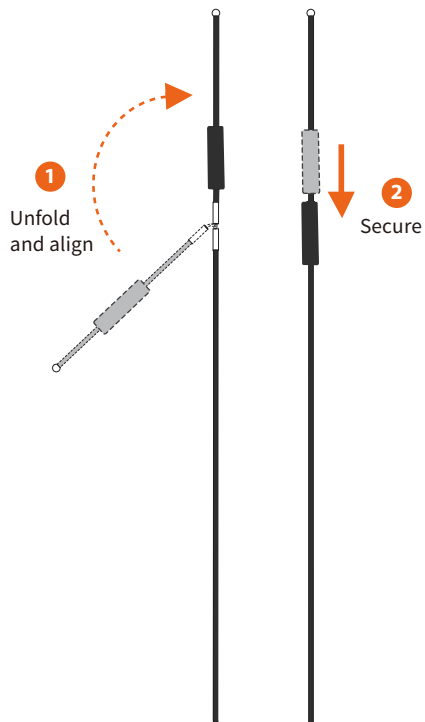

**WARNING** - Treat any loaded rod with caution until you are sure it is properly installed or uninstalled. Keep your face well away from any loaded rod.

- Assemble the black net rods as shown.
- Locate the pockets at the top edge of the net and install all of the black net rods.
- Take care to fully push the ball of the black net rod into the pocket as shown. There is an internal catch at the top of the pocket and the ball must be pushed past this internal catch or else it will come out. You will feel some resistance as the ball is pushed through.



**NOTE** - If you purchased a FlexrHoop™ with your trampoline, you could stop and install it right now. This will save you a couple of steps later.

10

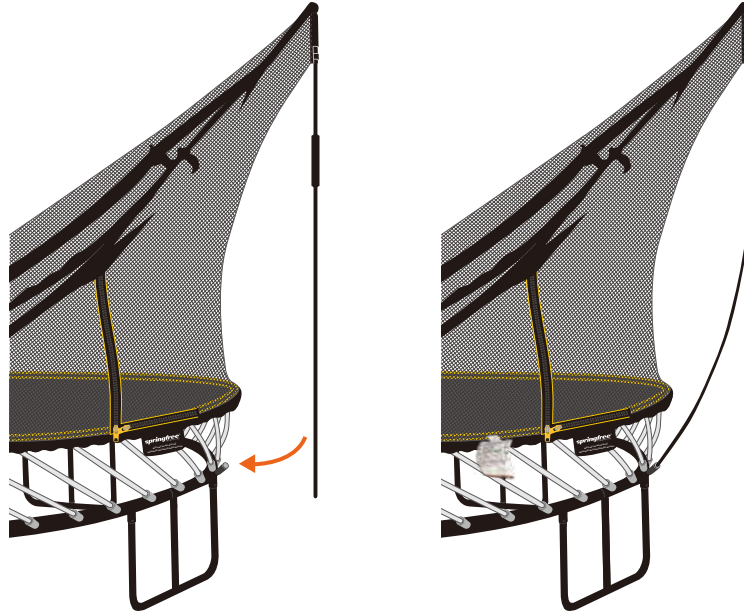

**WARNING** - Never attempt to remove a black net rod from its net rod pocket or disengage (unlock) the rod sleeve while the black net rod is under tension.

- To install the net, raise the black net rods and carefully flex the bottom of the rods into the corresponding net rod socket on the trampoline frame. Take care to completely insert the net rod into the socket. You will hear a click when the net rod is fully seated.
- For increased stability, your trampoline comes with sandbags. Fill these with sand and place over the trampoline legs as required.
- Congratulations! You have successfully installed your trampoline. Happy bouncing!



SCAN HERE or visit <http://springfr.ee/g4-step-10> for a helpful installation video for Step 10.

## 1

# Disassembly

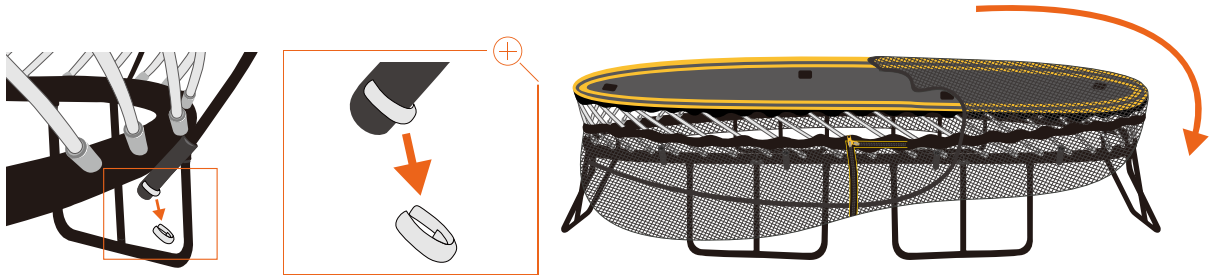

**WARNING** - Never remove a black net rod from its net rod pocket or disengage (unlock) the rod sleeve while the black net rod is under tension. First, remove the net rod from the net rod socket on the frame. Always ensure a solid grip when handling and do not stand directly in front of the rods.

- **Outside Person:** Remove the white c-clips located on the net rod sockets. Lift the bottom end of the black net rods out of the net rod sockets and lower the net.
- **Outside Person:** Remove the black net rods from the net rod pockets.
- **Outside Person:** Starting at a corner, carefully pull the top edge of the net down over the edge of the mat. Continue around the trampoline until the net is sitting at the bottom of the mat rods.



SCAN HERE or visit <http://springfr.ee/disassem> for a helpful disassembly demonstration video.



2a

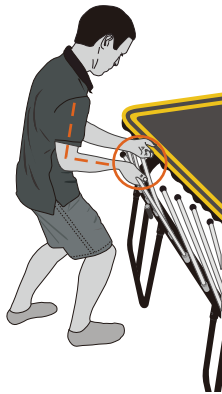

**1 Outside Person:**  
Hold the white mat rod with your palm facing up and bend your arm at a right angle.

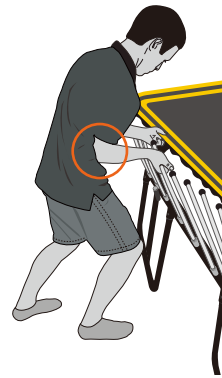

**2 Outside Person:**  
Stand with one leg forward and bend your knees. Push your elbow into your hip.

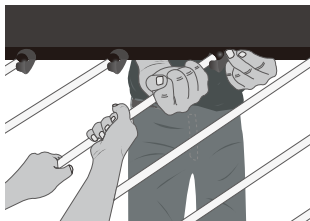

**3 Inside Person:**  
Take hold of the rod with both hands.



**4 Inside and Outside Person:**  
Ensure the outside person's hands are positioned as shown. Check that their left hand is tight against the corner of the mat rod holder but not obstructing the opening.



**WARNING** - Treat any loaded rod with caution until you are sure it is properly installed or uninstalled. Keep your face well away from any loaded rod.

2b



**5 Outside Person:** Push forward, rocking from your heels to the balls of your feet, using the weight of your body to push the white mat rod over the back edge of the mat rod holder. Keep the mat edge horizontal with your other hand.

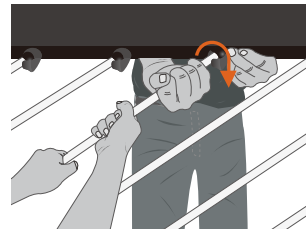

**6 Inside Person:** Once the ball comes to the back edge of the mat rod holder, pull the white mat rod down and out. Sometimes a forceful pull is needed to dislodge the ball from the mat rod holder.

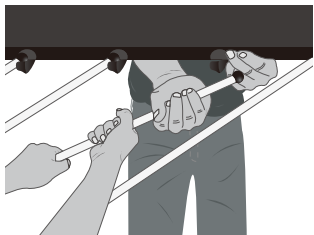

**7 Inside and Outside Person:** Lower the white mat rod and carefully ease it to a resting position.

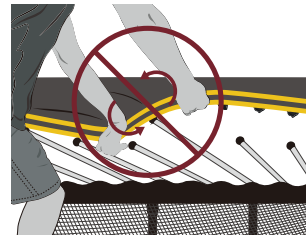

**8 Outside Person:** When you remove a rod from the mat, do not twist or rotate the mat edge as shown. This could cause serious injury or damage the trampoline.



**WARNING** - Treat any loaded rod with caution until you are sure it is properly installed or uninstalled. Keep your face well away from any loaded rod.

**WARNING** - Both people must maintain a steady grip on the rod until it is in its resting position.

# 3

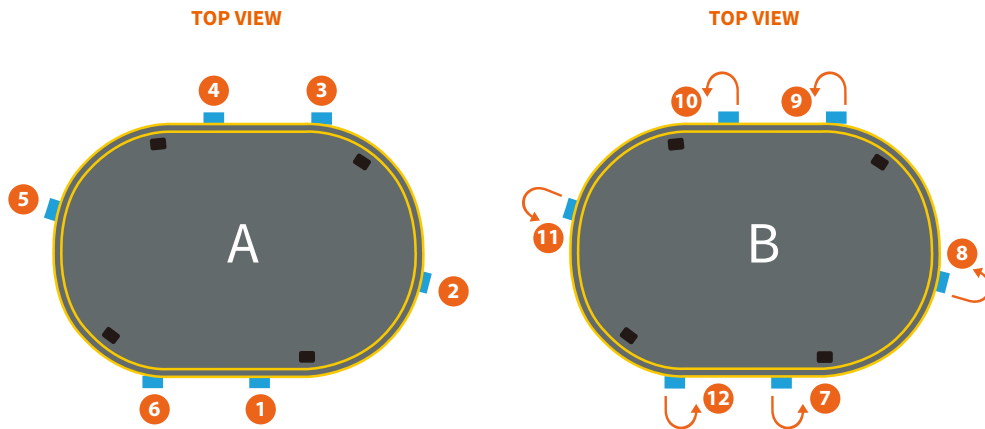

**WARNING** - Treat any loaded rod with caution until you are sure it is properly installed or uninstalled. Keep your face well away from any loaded rod.



**NOTE** - Following the sequence shown spreads the tension evenly across the mat. If you do not follow this sequence, it will be very difficult to remove the mat.

- Following the sequence shown in Image A and moving in a counter-clockwise direction, uninstall ONE white mat rod at each blue tag.
- Then following the sequence shown in Image B and still moving in a counter-clockwise direction, uninstall ONE additional rod next to each of the already uninstalled in figure A.
- Continue circling the trampoline in a counter-clockwise direction several more times following this sequence until all the white mat rods have been uninstalled.
- Remove the white mat rods from the frame and then pack the net, mat and rods.
- Disassemble the frame in the reverse order to which it was assembled.



# tgoma®



If you purchased tgoma® for your trampoline, scan here or visit <http://springfr.ee/s2-tgoma-install> for a helpful installation instructions. Alternatively, follow the instructions in your tgoma manual.



Springfree is the world's first and only Smart Trampoline. The four black sensor top plates on your mat mean that your trampoline is digitally enabled to create an interactive Smart Play experience when you purchase the tgoma game system. To find out how you can add tgoma to your Springfree, visit us online at [www.springfree.com](http://www.springfree.com).